

Table of Contents

Safety	3-4
Care of Stainless Steel.....	5
Technical Specifications	6
Installation & Start Up.....	7
Unpacking.....	7
Welding	7
Cleaning	7
General Maintenance.....	8
Service Intervals	8
Lubrication.....	8
Inspection	8
Assembly	9
Disassembly.....	10
Repair Kits	10
Bill of Materials	11
Part Number Key.....	12
Troubleshooting	13
Warranty	15

Safety

The following signs may be used in this manual. To avoid serious injury and/or possible damage to equipment, pay attention to these messages. Hazards or unsafe practices could result in severe personal injury or death.



Indicates a hazardous situation that, if not avoided, will result in death or serious injury.



Indicates a hazardous situation that, if not avoided, could result in death or serious injury.



Indicates a hazardous situation that, if not avoided, could result in minor or moderate injury. May also be used to alert against an unsafe operating or maintenance practice.

Use only replacement parts and devices recommended by the manufacturer to maintain the integrity of the equipment. Make sure the parts are properly matched to the series, model, serial number, and revision level of the equipment.

Safety labels are placed on equipment where appropriate. Do not remove any labeling from any piece of equipment. Replace any label that is missing.

DO NOT modify any Dixon® product. Non-factory modifications could create hazardous conditions and void all warranties. DO NOT attempt to use a Dixon product in any application that exceeds the product rating.

General Guidelines

- The owner must comply with these operating instructions and the authorized use of this piece of equipment. Should problems arise that cannot be solved using these operating instructions, please contact Dixon Sanitary. We will be happy to provide further assistance.
- If any modification work is performed on the product by the owner, Dixon shall no longer be considered the manufacturer of the device. In such cases, all components must be subjected to a new certification process for any applicable certifications that the equipment holds. Unless agreed to in writing by Dixon, liability, warranties, and guarantees shall immediately be deemed null and void as soon as you:
 - Perform modifications/conversion work on the product.
 - Use the product for unauthorized purposes.
 - Remove or disable safety elements.
 - Process products whose material, form, and size do not correspond exactly to the description provided.
 - Make alterations to the original state of the device.
- The operating instructions are regarded as part of the valve.
- The operating instructions shall be valid for the entirety of the devices lifespan.
- The operating and maintenance personnel must always be able to access the operating instructions.
- The safety instructions provided in the operating instructions must be observed.
- The operating instructions must be maintained and updated as necessary.
- The operating instructions must be passed on to any subsequent owners or operators of the device.

Safety

Owner Must Ensure...

- The product is used only as authorized.
- The product is used only when it is in fault-free, fully functional condition and the safety equipment is regularly checked to ensure that it is fully functional.
- The product is operated, maintained, and repaired only by personnel with the appropriate qualifications and authorization.
- Checks are made before the product is put into operation to ensure that only the authorized person is in the work area and no one is in danger of being injured if the product is in operation.
- The product is checked for visual damage prior to commissioning to ensure that it is operated only when free of faults.
- Any defects are reported immediately to the appropriate supervisor.
- All safety and warning notices attached to the equipment are legible, and none are removed.
- The operating instructions are always kept close to the product operation site, in a legible and complete state.
- Personnel are regularly instructed on all occupational safety and environmental protection issues and are familiar with and observe the operating instructions, especially the safety instructions contained herein.
- Personnel are trained and supervised to ensure that they follow safety measures, including the obligatory use of personal protective equipment.
- The product is only connected to pipelines that are depressurized at the time of connection.
- There is no tensile or compressive stress acting on the product connections.
- There is no residual risk at any point where pressure could occur. Pressure can cause sudden failure in or damage to the lines and connections.
- Warning notices in the documentation for supplier modules are observed and integrated into the risk assessments in the workplace.

Care of Stainless Steel

The stainless steel components in Dixon® Sanitary equipment are machined, welded, and assembled by skilled craftsmen using manufacturing methods that preserve the corrosion-resistant quality of the stainless steel. Retention of corrosion-resistant qualities under processing conditions requires regular attention to the precautions listed below. Examples of corrosion that can result from improper care are included below.

- Regularly check all electrical devices connected to the equipment for stray currents caused by improper grounding, damaged insulation, or other defects. Corrosion: Pitting often occurs when stray currents encounter moist stainless steel.
- Never leave rubber mats, fittings, wrenches, or other tools in contact with stainless steel. Corrosion: pitting or galvanic action. Objects retard complete drying, preventing air from reforming the protective oxide film. Galvanic corrosion occurs when two dissimilar metals touch when wet.
- Immediately rinse equipment after use with warm water until the rinse water is clear. Clean the equipment (COP or CIP) as soon as possible after rinsing. Corrosion: discoloration, deposits, and pitting. Product deposits often cause pitting beneath the particles.
- Use only recommended cleaning compounds. Purchase chemicals from reputable and responsible chemical manufacturers familiar with stainless steel processing equipment. Ensure they continuously check the effects of their products on stainless steel.
- Use cleaning chemicals exactly as specified by the manufacturer. Do not use excessive concentrations, temperatures, or exposure times. Corrosion: pitting, discoloration, or stress cracks. Permanent damage often occurs from excessive chemical concentrations, temperatures, or exposure times.
- For manual cleaning, use only soft non-metallic brushes, sponges, or pads. Brush with the grain on polished surfaces to avoid scratching the surface. Corrosion: pitting, scratches. Metal brushes or sponges will scratch the surface and promote corrosion over a period of time. Metal particles allowed to remain on a stainless steel surface will cause pitting.
- Use chemical bactericides exactly as prescribed by the chemical manufacturer in concurrence with the local health authority. Use the lowest permissible concentration, temperature, and exposure time possible. Flush immediately after bacterial treatment. In no case should the solution be in contact with stainless steel for more than 20 minutes. Corrosion: protective film destroyed. Chlorine and other halogen bactericides can destroy the protective film. A few degrees increase in temperature greatly increases chemical activity and accelerates corrosion.
- Regularly inspect the joints in pipelines. Be sure all connections are tight fitting without binding. Corrosion: crevice corrosion. Small crevices caused by improperly seated gaskets will promote crevice corrosion. Stainless steel under stress will develop stress cracking, especially in the presence of bactericides containing chlorine.
- Regularly inspect equipment for surface corrosion (i.e. pitting deposits, stress cracks, etc.). If deposit or color corrosion is detected, remove it immediately using mild scouring powder and detergents. Rinse thoroughly and allow to air dry. Review production and cleaning procedures to determine the cause. NOTE: If corrosion is not removed, the protective film cannot be restored, and corrosion will continue at an accelerated rate.



Technical Specifications

Materials of Construction Technical Data

- Product contact components: 316L stainless steel
- Non-product contact components: 304 stainless steel

Sealing Materials Technical Data

- Product contact components: PTFE, EPDM, and silicone (based on configuration purchased)

Line Pressure and Product Temperature Technical Data

Tube O.D.	PSI at 70°F (21°C)	PSI at 200°F (93°C)
1"	500	300
1-1/2"	500	300
2"	450	250
2-1/2"	400	200
3"	350	175
4"	300	150

Surface Finish Technical Data

- Product contact components: Ra ≤ 32
- Additional finishes available upon request

Connections

- Clamp (standard)
- Weld
- Custom connections available upon request

Cleaning Method

- COP - all models

Swivel Torque Requirements

Tube O.D.	Torque (in-lbs.)
1"	50
1-1/2"	50
2"	50
2-1/2"	125
3"	125
4"	600

Installation and Start Up

The following should be performed upon receiving the product and prior to installation and use of the product. It is important that all the following processes and procedures are carefully followed and adhered to. Dixon® is not responsible for any damage that occurs during the unpacking or installation process.

Unpacking

Carefully unpack the SJSS-series swivel and inspect for any damage that may have occurred during shipment. Report any damage to the carrier immediately. The ports on the swivel are protected with a plastic cover. If any covers are missing or damaged, inspect the ports on the valve thoroughly for any damage. The swivel is shipped with all necessary certificates and manuals. Please add this paperwork to the plant maintenance files for future use and reference. Additional information for the valve can be found at dixonvalve.com.

Welding

- For equipment delivered with weld end connections, any rubber or plastic components **MUST** be removed from the equipment prior to welding (see disassembly instructions for proper removal of such components).
- Follow all necessary safety precautions, check lists, and standard procedures prior to performing any welding on the equipment.
- Weld the equipment into the process line, being sure to follow and comply with appropriate industry welding procedures and standards. For equipment used in the food, beverage, or dairy applications that carries 3A certification, see 3A standard 00-01-2018 section E1.1.1 for proper procedure and requirements.
- Reassemble the equipment per the assembly section of this manual.
- Check the equipment for proper operation and perform a leak test if necessary.

Function Testing

- Check visually to ensure that the equipment is not leaking.
- Any defective seal that could have been damaged during disassembly or assembly must be replaced.
- Check all equipment components for any signs of damage and replace damaged components.
- Ensure that all screw fittings are tight if applicable.
- Ensure that any pneumatic hose connections are free of leaks if applicable.
- Confirm all pipes and fittings that are connected to the equipment permitted for use are in the intended pressure range.
- Confirm all electrical installations are protected and in accordance with appropriate safety standards.
- Check that the maximum pressure indicated on the equipment or in the specifications section of this manual have been complied with.

Cleaning

IMPORTANT: Before operating the equipment during formal production, please follow the guidelines listed below to ensure that your equipment is clean and ready for service.

- Ensure that the equipment is installed in a proper orientation to allow the equipment to be cleaned and drained properly. Reference the installation and start up section of this manual for orientation guidelines.
- Flush the equipment with an appropriate cleaning agent to remove any residue that may be on the equipment from shipping.
IMPORTANT: DO NOT use cleaning agents that will attack stainless steel or the elastomers that were supplied with the valve. If you are unsure what elastomer is used in the valve, reference the part number key in this manual to make the determination. Follow any MSDS instructions for proper use or handling of cleaning agents.
- Flush the equipment to remove any soiling from the product contact components. Depending on the process, there may be varying amounts of soiling. Cleaning times and cleaning agent concentrations will vary depending on the product being processed. It is the responsibility of the operator to determine and adjust these cleaning specifications as necessary.
- The equipment should not be allowed to sit with product present in it for extended periods of time.
- Equipment should be cleaned immediately after processing is complete.

General Maintenance

To ensure proper operation of your Dixon® equipment, proper maintenance must be performed at regular intervals. To prevent damage, check all fitting connections and screw connections for any loosening of the connections during equipment operation. Maintain adequate spare parts stock for all replacement components on the piece of equipment. Please refer to the repair kits section of the manual for complete component part numbers and kit part numbers.

Service Intervals

Recommended intervals for a one shift operation would be three months. However, only the user/owner can determine the appropriate service intervals as the length between service intervals is dependent on the following parameters:

- Duration of use per day - number of cycles
- Type of product
- Product temperature
- Product viscosity
- Cleaning agent

Lubrication

Please use the chart below for proper grease types for varying component materials. DO NOT use mineral or animal-product-based greases. Check all visible seals for any signs of damage and replace as necessary. For sliding surfaces, use a chemically compatible food grade grease. If a different grease is used other than what is specified in this manual, there is a risk of damaging the seals. Lubrication is only required when the equipment is being reassembled after servicing.

Seal Material	Grease Type
EPDM/FKM/Nitrile Rubber	compatible non-mineral/non-animal based
PTFE	do not grease

Inspection

Inspection of the components listed below should be done during regular servicing intervals. Before removing the equipment from the process line, please do the following:

- Clean the process line completely to remove any product that may be harmful if coming in contact with a person.
- Drain the process line completely that connects to the equipment being serviced.
- Close any isolation valves on either side of the equipment being serviced.
- Once the equipment has been removed from the line, cap the lines that were connected to the piece of equipment being serviced to prevent any foreign material from entering the line.

Any components that show signs of severe wear or damage should be replaced during the scheduled maintenance time for the equipment. Please refer to the assembly and disassembly section of this manual for proper instructions on removing and replacing any worn or damaged components. Replacement components and repair kits can be found in the bill of materials or repair kits section of this manual.

Manual Cleaning (COP)

1. Refer to the disassembly section of the manual and follow instructions to remove all product contact components.
2. Inspect the product contact components of the equipment for any signs of possible damage. Replace components as necessary (see the equipment BOM in this manual for replacement part numbers).
3. Clean all surfaces of the product contact components by manually brushing in a bath of cleaning solution (acid detergents or simple alkaline soda type detergents).
4. After cleaning, rinse all components thoroughly with water.
5. Refer to assembly section of this manual and follow instructions to properly reassemble the equipment.

Assembly and Disassembly

To ensure proper operation of your Dixon® equipment, the equipment must be disassembled and assembled properly to prevent equipment damage during operation. Please follow the instructions contained in this manual carefully and be sure to follow any safety warnings contained herein. If any questions should arise during the assembly or disassembly process that are not addressed in this manual, please feel free to contact Dixon Sanitary at 800.789.1718.

Assembly

1. Place the outer body (**item 8**) on a table, end connection down.
2. Lubricate the inside walls of the outer body (**item 8**).
3. Insert the outer body gasket (**item 7**) into the outer body (**item 8**) and slide all the way down.
4. Insert the lower body washer (**item 6**) on top of the outer body gasket and apply chemically compatible food grade grease to it.
5. If the inner body is:
 - a. Weld end
 - i. Place the inner body on a table, end connection down.
 - ii. Apply chemically compatible food grade grease to the inner body gasket groove.
 - iii. Slide the PTFE inner body bushing (**item 4**) onto the O.D. of the inner body (**item 2**) until it touches the bottom face (only on 4" size).
 - iv. Insert the inner body gasket (**item 6**).
 - v. Apply chemically compatible food grade grease to the inner body.
 - b. Clamp end
 - i. Place the inner body on a table, end connection down.
 - ii. Apply chemically compatible food grade grease to the inner body gasket groove.
 - iii. Slide the PTFE inner body bushing (**item 4**) onto the O.D. of the inner body (**item 2**) until it touches the bottom face (only on 4" size).
 - iv. Insert the inner body gasket (**item 5**).
 - v. Apply chemically compatible food grade grease to the inner body.
6. Slip the inner body (**item 2**) into the outer body (**item 8**), keeping the two bodies parallel until it stops.
7. Place the upper body seat (**item 3**) and then the upper body (**item 1**) over the inner body (**item 2**) regardless of end style.
8. Clamp the bodies together with the supplied SJSSMHHM clamp (**item 9**), tightening the wing nut to 25 in-lbs of torque.

Parts where lubrication is applied during assembly:

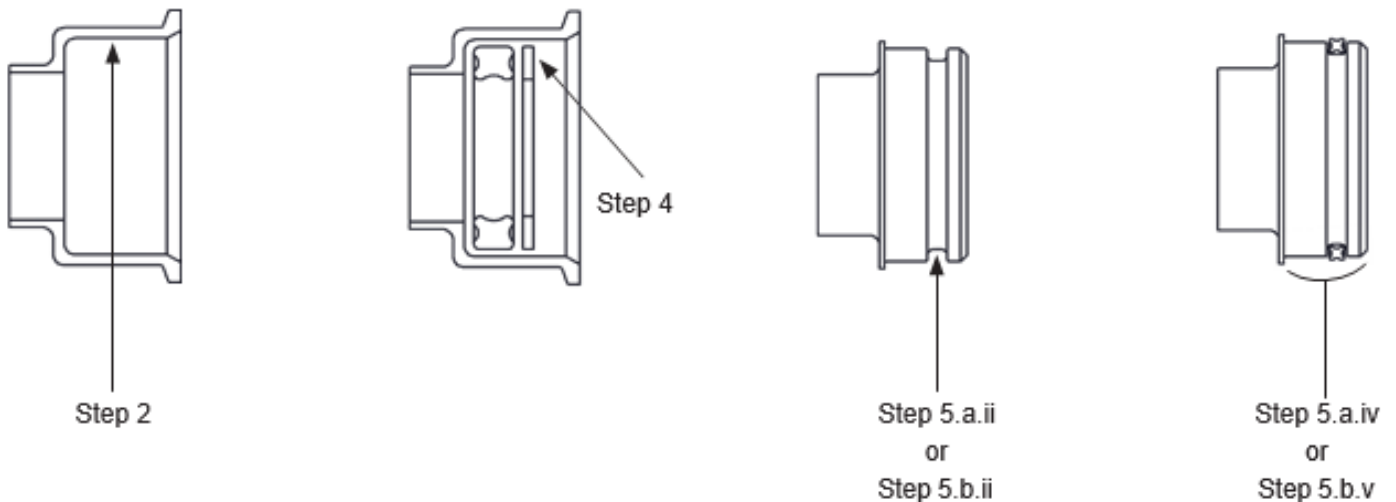

Assembly and Disassembly

Disassembly

1. Place the swivel on a table with the outer body facing down.
2. Remove the clamp from the bodies.
3. Slide the upper body and upper body seat away from the swivel.
4. Pull the inner body straight out, being careful not to angle it.
5. The upper body seat, inner body gasket, lower body washer, and outer body washer can now be removed gently, to avoid damage to the seals or bodies.

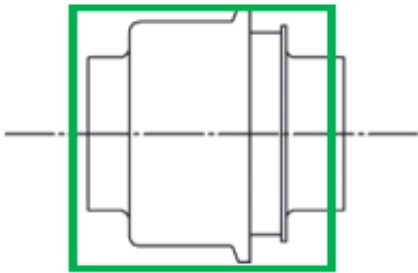

Repair Kits

To ensure proper operation of your Dixon® equipment, proper maintenance must be performed at regular intervals. To prevent damage and improper operation, use only genuine replacement parts and kits offered by Dixon to maintain the integrity of the equipment. Make sure the parts are properly matched to the series model, serial number, and revision level of the equipment. Please see the list of kits below offered for this piece of equipment:

Individual repair kit components are available. Contact Dixon Sanitary for more information at 800.789.1718.

Tube O.D.	Contents	Silicone	EPDM
1"	(1) inner body gasket (1) outer body gasket (1) upper body seat (1) lower body washer	SJSS-REPAR-S100	SJSS-REPAR-E100
1-1/2"		SJSS-REPAR-S150	SJSS-REPAR-E150
2"		SJSS-REPAR-S200	SJSS-REPAR-E200
2-1/2"		SJSS-REPAR-S250	SJSS-REPAR-E250
3"		SJSS-REPAR-S300	SJSS-REPAR-E300
4"		SJSS-REPAR-S400	SJSS-REPAR-E400

Bill of Materials

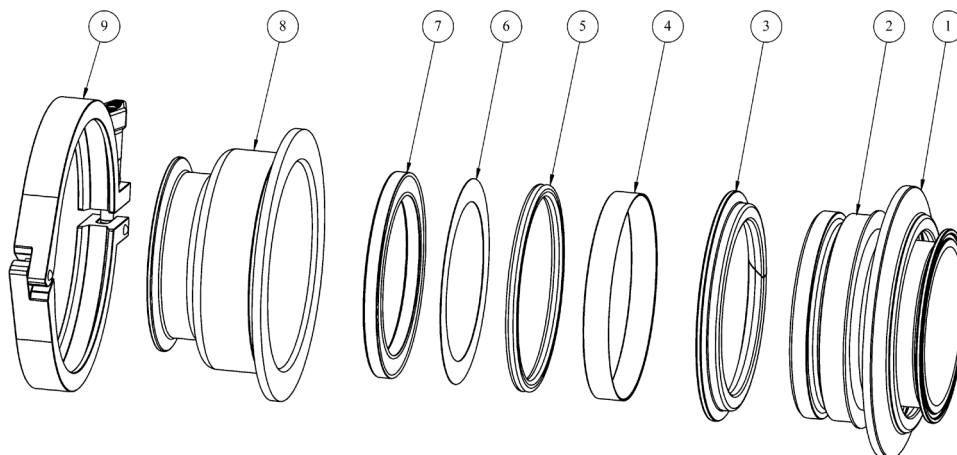







Clamp Style End Connection Shown

Item #	Part # *	Description	Material
1	SJSS-32CP5-___	upper body	316L
2	SJSS-32CP3-___	inner body - clamp	316L
	SJSS-32CP1-___	inner body - weld	316L
3	SJSS-PSEAT-P___	upper body seat	PTFE
4	SJSS-32CP3B-400	inner body bushing **	POM
5	SJSS-INBG-E___	inner body gasket	EPDM
	SJSS-INBG-S___		Silicone
6	SJSS-LBWSH-___	lower body washer	PTFE
7	SJSS-OUTBG-E___	outer body gasket	EPDM
	SJSS-OUTBG-S___		Silicone
8	SJSS-32CP4-___	outer body - clamp	316L
	SJSS-32CP2-___	outer body - weld	316L
9	SJSSMHM-___	body clamp	304

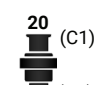
* Part number key size: 1" = 100, 1-1/2" = 150, 2" = 200, 2-1/2" = 250, 3" = 300, 4" = 400

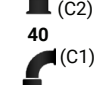
** Only used on 4" size.

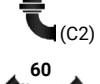
Part Number Key

SJSS-Series Swivel Part Number Key Example: SJSS100SCC120		Series	Size	Gaskets	End Connection 1	End Connection 2	Surface Finish	Style	Clamp
		SJSS	100	E	C	C	1	20	B
Series	Code								
SJSS	SJSS	←							
Size	Code								
1"	100	←							
1-1/2"	150								
2"	200								
2-1/2"	250								
3"	300								
4"	400								
Gasket	Code								
EPDM	E	←							
Silicone	S								
End Connection One (C1)	Code								
Clamp (standard)	C	←							
Weld	B								
Female I-Line	F								
Male I-Line	M								
Threaded Bevel	T								
Plain Bevel with Nut	P								
Q-Line	Q								
End Connection Two (C2)	Code								
Clamp (standard)	C	←							
Weld	B								
Female I-Line	F								
Male I-Line	M								
Threaded Bevel	T								
Plain Bevel with Nut	P								
Q-Line	Q								
Surface Finish	Code								
32 Ra (I.D. Mech. Polished)	1	←							
25 Ra (I.D. Mech. Polished)	2								
20 Ra (I.D. Mech. Polished)	3								
15 Ra (I.D. Mech. Polished)	4								
10 Ra (I.D. Mech. Polished)	5								
Styles	Code								
 (C1)	20	←							
 (C1)	30								
 (C2)	40								
 (C1)	50								
 (C2)	60								
 (C2)	70								
Clamp	Code								
Single pin clamp (standard)	blank								
Bolted clamp	B	←							

Troubleshooting

Problem	Possible Cause	Suggested Action
The swivel requires too much torque to rotate.	Too little or no lubrication.	Add lubrication per assembly instructions.
	The lower body washer is assembled in the wrong order.	Assemble per assembly instructions.
	Moment arm is too short or missing.	Add or lengthen the moment arm.
Fluid is leaking from the swivel.	There is damage to the gaskets.	Replace the gaskets if damaged or torn.
No flow through the swivel.	Obstruction in the swivel.	Disassemble and inspect the interior.
PTFE shavings appear.	Wear and tear of the upper body seat.	While some shavings will occur as part of normal use, replace the upper body seat if extensive damage occurs.
The clamp is grinding or assembled poorly.	The SJSS clamp was swapped with another clamp.	Replace the added clamp with the SJSS clamp that came with the swivel.

Limited Warranty

DIXON VALVE AND COUPLING COMPANY, LLC (herein called "Dixon") warrants the products described herein and manufactured by Dixon to be free from defects in material and workmanship for a period of one (1) year from date of shipment by Dixon under normal use and service. Its sole obligation under this warranty being limited to repairing or replacing, as hereinafter provided, at its option any product found to Dixon's satisfaction to be defective upon examination by it, provided that such product shall be returned for inspection to Dixon's factory within three (3) months after discovery of the defect. The repair or replacement of defective products will be made without charge for parts or labor. This warranty shall not apply to: (a) parts or products not manufactured by Dixon, the warranty of such items being limited to the actual warranty extended to Dixon by its supplier; (b) any product that has been subject to abuse, negligence, accident, or misapplication; (c) any product altered or repaired by others than Dixon; and (d) to normal maintenance services and the replacement of service items (such as washers, gaskets, and lubricants) made in connection with such services. To the extent permitted by law, this limited warranty shall extend only to the buyer and any other person reasonably expected to use or consume the goods who is injured in person by any breach of the warranty. No action may be brought against Dixon for an alleged breach of warranty unless such action is instituted within one (1) year from the date the cause of action accrues. This limited warranty shall be construed and enforced to the fullest extent allowable by applicable law.

Other than the obligation of Dixon set forth herein, Dixon disclaims all warranties, express or implied, including but not limited to any implied warranties of merchantability or fitness for a particular purpose, and any other obligation or liability. The foregoing constitutes Dixon's sole obligation with respect to damages, whether direct, incidental or consequential, resulting from the use or performance of the product.

Some products and sizes may be discontinued when stock is depleted or may require a minimum quantity for ordering.

